

# **HIKOKI**

---

## **RP 3608DA**

---

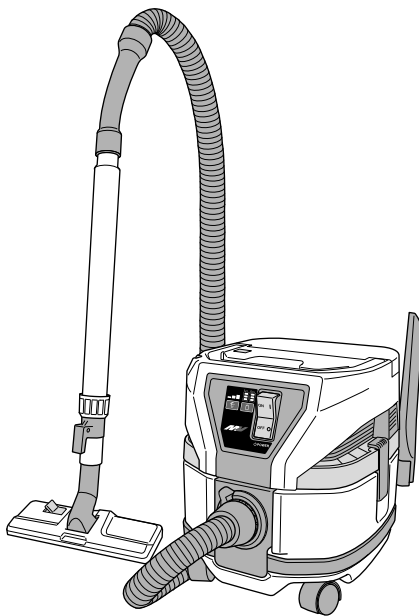

Handling instructions

1

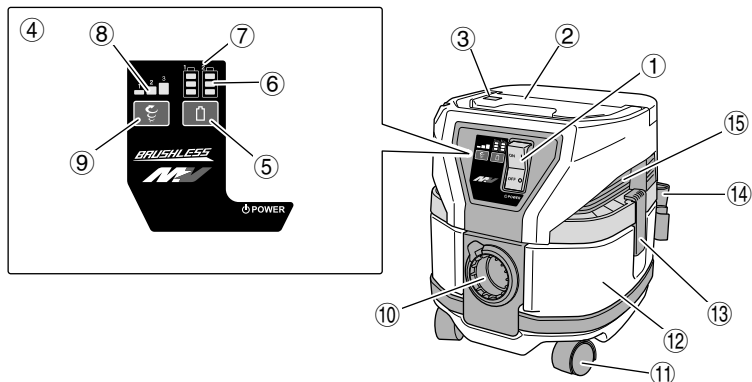

2

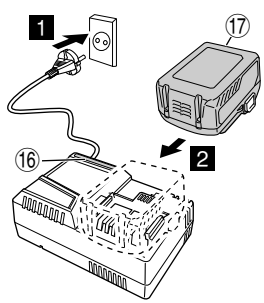

3

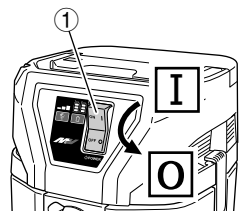

4

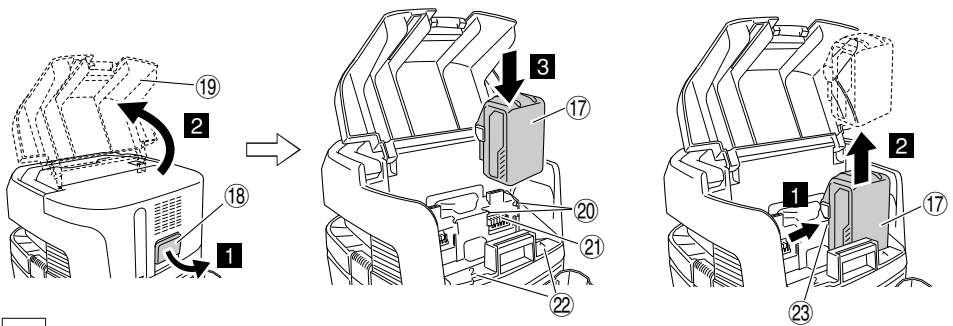

O

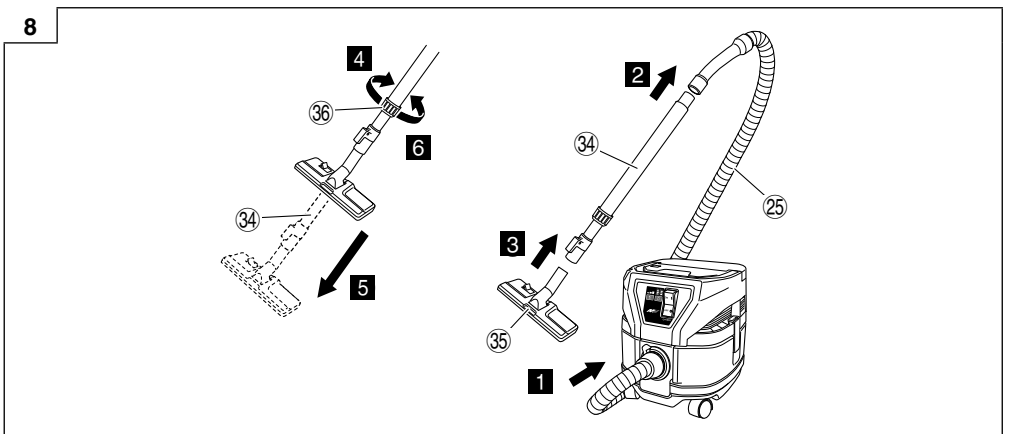
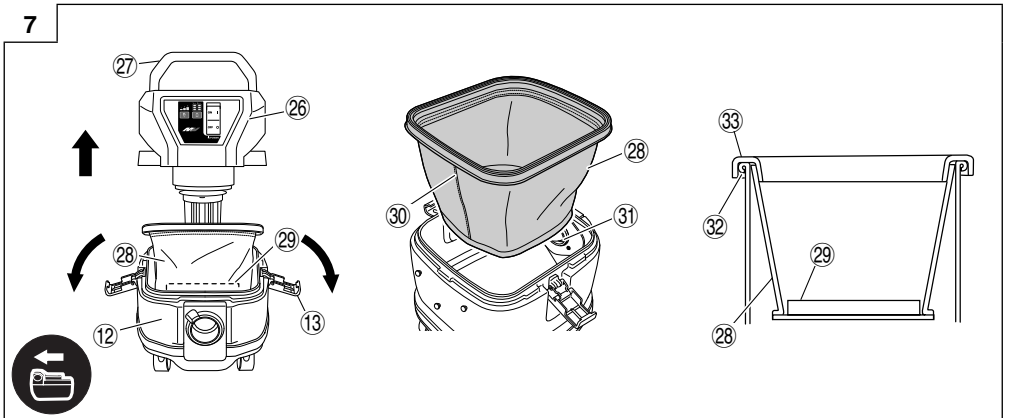
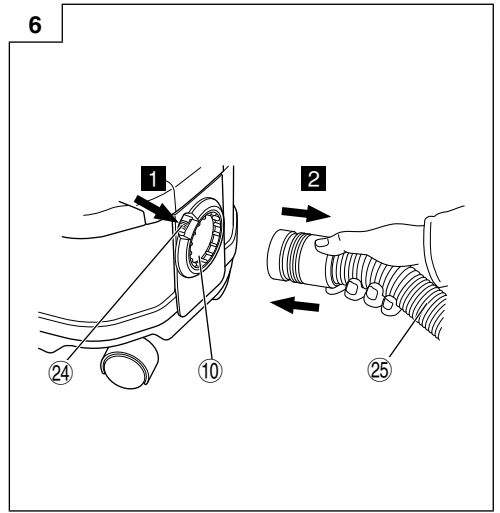
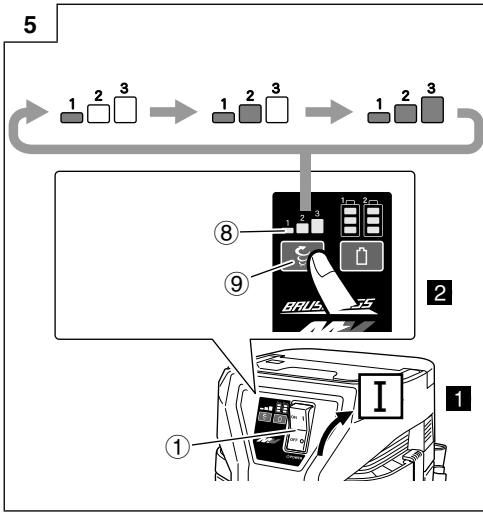

9

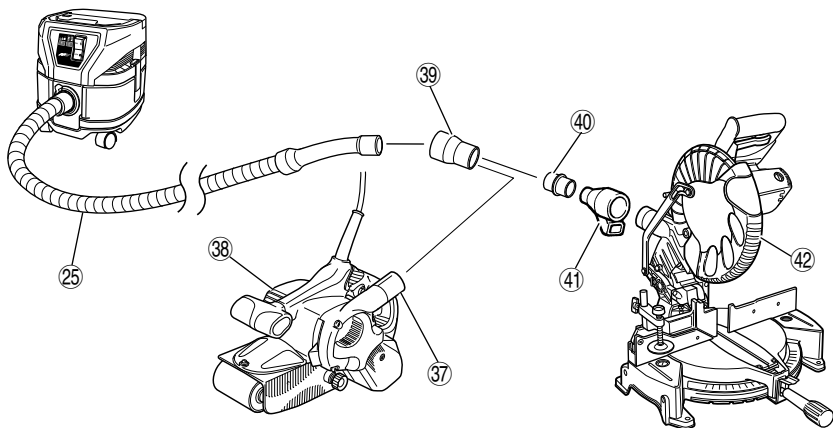

10

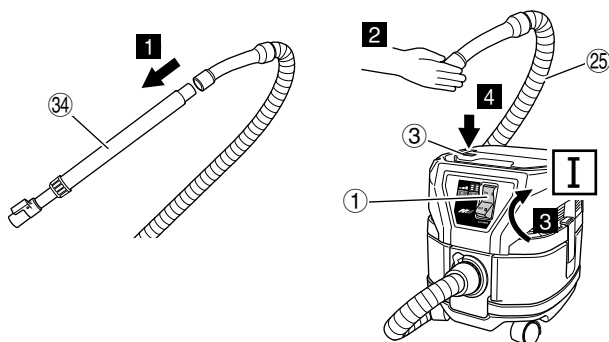

11

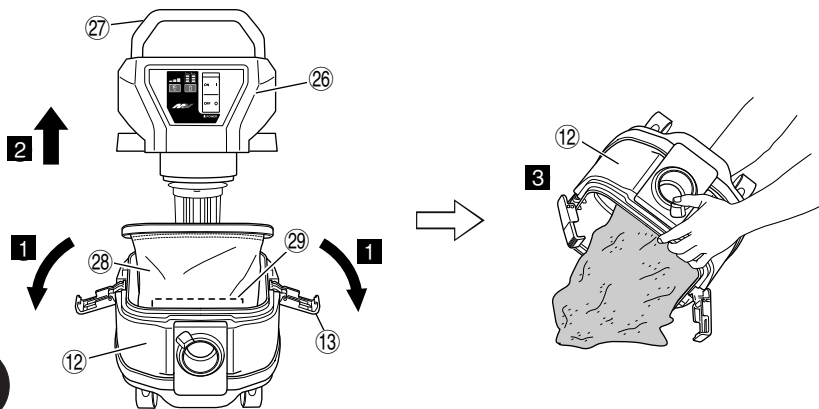

12

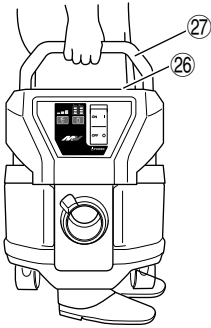

13

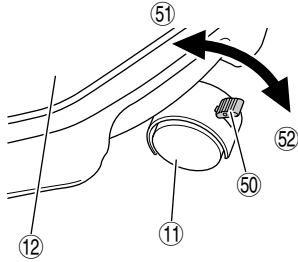

14

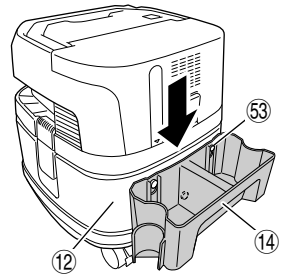

15

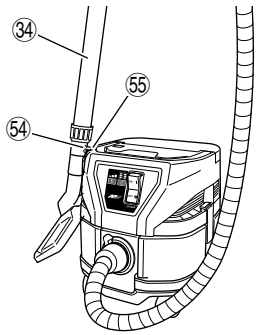

16

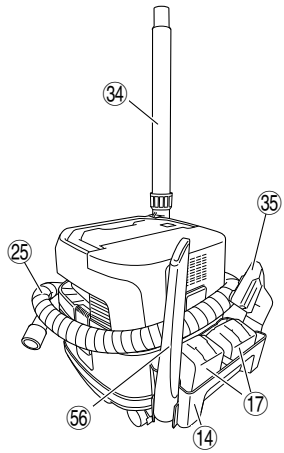

17

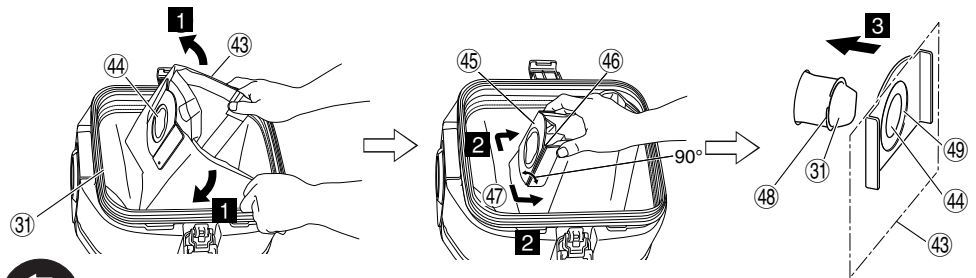

18

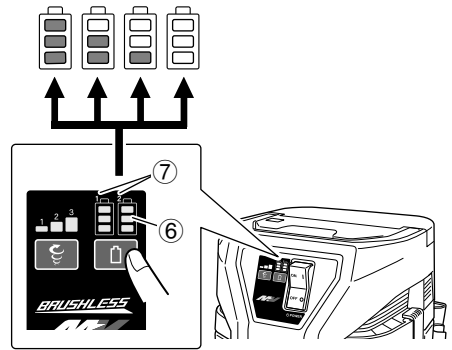
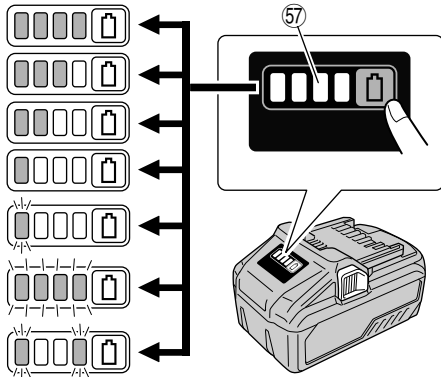

19

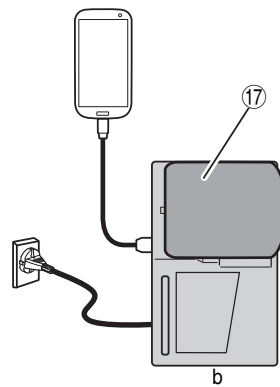
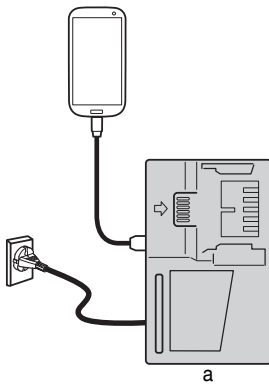

20

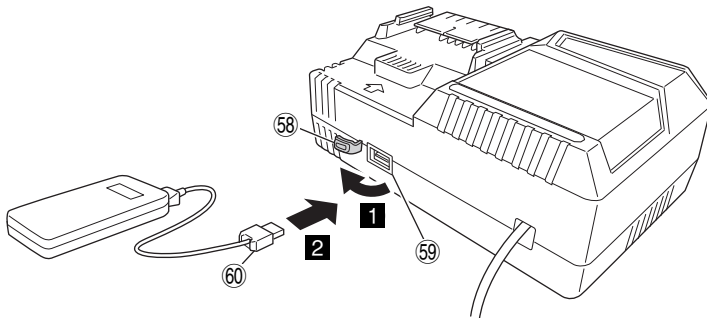

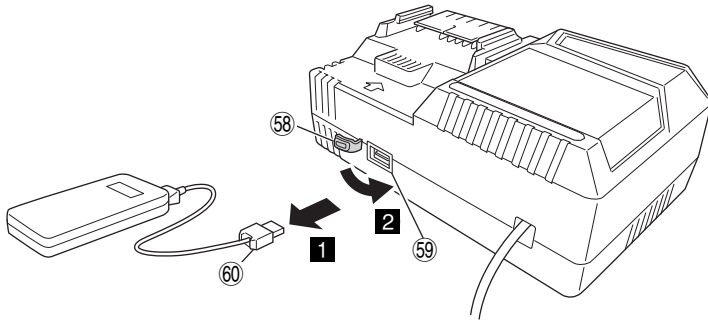

## SAFETY PRECAUTIONS FOR THE CORDLESS CLEANER

- In order to prevent accidents, such as fires, electric shock, and injuries, be sure to follow the "Safety Precautions" stated below.
- Before use, read all of the "Safety Precautions" and use the appliance correctly according to the instructions.
- Be sure to keep this instructions manual in the place where it can be consulted by the user at any time.

### WARNING

1. Keep the workplace clean. Littered place or workbench may cause accidents.
2. Pay attention to the situation around the workplace as well. Make the workplace bright enough. Do not use the appliance in places with inflammable liquid or gas.
3. Keep children away. Do not let other persons than the operator touch the cleaner or the cord. Keep persons other than the operator away from the workplace.
4. Use the cleaner suitable for the work. Use the appliance only for the specified applications.
5. Do not handle the power cord roughly.
- Do not carry the charger with only the power cord or pull the plug from the socket while holding the power cord.
- Keep the power cord away from heat, oil and sharp corners.
6. The cleaner should be maintained carefully. Replacement of accessories should follow the instructions manual. Regularly check the power cord of the charger and ask your dealer for repairs in the event of it being damaged. If an extension cord is used, check it periodically, and when damaged, replace it.
7. In the following cases, switch off the cleaner and turn OFF the main power supply:  
The cleaner is not used or it is sent for repair.  
Accessories, such as a hose and a filter, are replaced.  
Danger is expected.
8. Avoid sudden starting. Do not carry the appliance which is connected to the power supply with your finger placed on the switch. Confirm that the switch is off before insert the battery.
9. Do the work with enough care. When you use the cleaner, pay attention to the handling method, how to do the work, the surrounding situation, etc. and perform the operation in a cautious manner. When you do the work at a distance from the cleaner, pay attention to the operation condition of the cleaner. (abnormal sound, dust blow off, emitting smoke, etc.) Exercise common sense. Do not use the appliance when you are tired.
10. Check for any damaged part.
  - Before use, check for any damages in the protective cover or other parts and confirm whether the appliance operates normally and performs specified functions.
  - Check for any abnormalities in all places that may affect the operation, the position adjustment and clamping state of movable portions, damaged parts or attachment state.
  - Replacement and repair of damaged protective cover and other parts should follow the provisions of the handling instructions. If there are no such provisions in the manual, please request repair from your local retailer or authorized servicing agent.
  - If the switch fails, please request repair from your local retailer or authorized servicing agent. Avoid using the cleaner which cannot be started or stopped by the switch.
11. Contact the specialty store for repair of the cleaner.
- Since this cleaner conforms to the corresponding safety standard, do not modify it.

- Be sure to request repair from your local retailer or authorized servicing agent. Self-repair may cause accidents or injuries.
- 12. Never allow children, persons with reduced physical, sensory or mental capabilities, or lack of experience and knowledge to use the appliance. Children shall not play with the appliance.
- 13. Operators shall be adequately instructed on the use of the appliance.
- 14. This appliance is not suitable for picking up hazardous dust.
- 15. If foam or liquid escapes from the appliance, switch off immediately.
- 16. Clean the water level limiting device regularly and examine it for signs of damage.

## PRECAUTIONS FOR USE OF THE CORDLESS CLEANER

The precautions common to the cleaners have been described. For the cleaners for electric tools, follow further precautions described below:

### WARNING

1. Prevent the appliance from sucking in the following:
  - Generated spark during metal grinding or cutting.
  - High temperature things, such as lighted cigarette.
  - Inflammable substances (gasoline, thinner, benzine, kerosene, paint, etc.), explosive substances (nitroglycerine, etc.), combustible substances (aluminum, zinc, magnesium, titanium, red phosphorus, yellow phosphorus, celluloid, etc.)
  - Sharp things, such as nail and razor.
  - Wood chip, metal, stone, string, etc.
  - Solidification materials, such as cement powder and toner, and conductive fine dusts, such as metal powder and carbon powder.
  - Foaming liquids, such as oil, boiling water, chemical fluid, and detergent. Liquids, such as water and oil. May cause fires or injuries.
2. Set the filter correctly before use. Do not use the appliance without the filter or with it set in a wrong position, or do not use a torn filter. May cause failures, such as motor burnout.
3. Do not use the appliance with its suction opening, air inlet or exhaust opening obstructed. The temperature of the motor may rise abnormally, causing troubles such as deformation of parts or motor burnout.
4. Do not operate the appliance when its float is operating or when its hose or suction mouth, etc. is clogged with foreign matter. The temperature of the motor may rise abnormally, causing troubles such as deformation of parts or motor burnout.
5. Do not topple the appliance or do not use it on its side. May cause electric shock or failures.
6. To prevent deformation or breakage of the appliance due to toppling etc., the appliance should be moved calmly. Breakage, crack, or deformation may cause injuries.
7. When you drop or bump the appliance accidentally, check for breakage, crack, or deformation in the appliance. Breakage, crack or deformation may cause injuries.
8. When the appliance is out of condition or emits abnormal sound during use, immediately turn off the switch and request repair from your local retailer or authorized servicing agent. If you continue to use the appliance as it is, it may lead to injuries.
9. This appliance is designed for industrial use. This appliance is only used indoors. Never use it outdoors. Insulation deterioration may cause electric shock or electrical fire. This appliance shall be stored indoors only.



10. Do not use the product if the tool or the battery terminals (battery mount) are deformed. Installing the battery could cause a short circuit that could result in smoke emission or ignition.
11. Keep the tool's terminals (battery mount) free of swarf and dust.
  - Prior to use, make sure that swarf and dust have not collected in the area of the terminals.
  - During use, try to avoid swarf or dust on the tool from falling on the battery.
  - When suspending operation or after use, do not leave the tool in an area where it may be exposed to falling swarf or dust.
  - Wipe clean any dust, dirt, water or other liquid which may collect on the battery connector. Doing so could cause a short circuit that could result in smoke emission or ignition.
12. Do not dispose of the battery in fire. If the battery is burnt, it may explode.
13. Bring the battery to the shop from which it was purchased as soon as the post-charging battery life becomes too short for practical use. Do not dispose of the exhausted battery.
8. Do not put or subject the battery to high temperatures or high pressure such as into a microwave oven, dryer, or high pressure container.
9. Keep away from fire immediately when leakage or foul odor are detected.
10. Do not use in a location where strong static electricity generates.
11. If there is battery leakage, foul odor, heat generated, discolored or deformed, or in any way appears abnormal during use, recharging or storage, immediately remove it from the equipment or battery charger, and stop use.
12. Do not immerse the battery or allow any fluids to flow inside. Conductive liquid ingress, such as water, can cause damage resulting in fire or explosion. Store your battery in a cool, dry place, away from combustible and flammable items. Corrosive gas atmospheres must be avoided.

#### CAUTION

1. If liquid leaking from the battery gets into your eyes, do not rub your eyes and wash them well with fresh clean water such as tap water and contact a doctor immediately.
  - If left untreated, the liquid may cause eye-problems.
2. If liquid leaks onto your skin or clothes, wash well with clean water such as tap water immediately. There is a possibility that this can cause skin irritation.
3. If you find rust, foul odor, overheating, discolor, deformation, and/or other irregularities when using the battery for the first time, do not use and return it to your supplier or vendor.

### CAUTION ON LITHIUM-ION BATTERY

To extend the lifetime, the lithium-ion battery equips with the protection function to stop the output. In the cases of 1 to 3 described below, when using this product, even if you are pulling the switch, the motor may stop. This is not the trouble but the result of protection function.

1. When the battery power remaining runs out, the motor stops.
  - In such a case, charge it up immediately.
2. If the tool is overloaded, the motor may stop. In this case, release the switch of tool and eliminate causes of overloading. After that, you can use it again.
3. If the battery is overheated under overload work, the battery power may stop.
  - In this case, stop using the battery and let the battery cool. After that, you can use it again.

Furthermore, please heed the following warning and caution.

#### WARNING

In order to prevent any battery leakage, heat generation, smoke emission, explosion and ignition beforehand, please be sure to heed the following precautions.

1. Make sure that swarf and dust do not collect on the battery.
  - During work make sure that swarf and dust do not fall on the battery.
  - Make sure that any swarf and dust falling on the power tool during work do not collect on the battery.
  - Do not store an unused battery in a location exposed to swarf and dust.
  - Before storing a battery, remove any swarf and dust that may adhere to it and do not store it together with metal parts (screws, nails, etc.).
2. Do not pierce battery with a sharp object such as a nail, strike with a hammer, step on, throw or subject the battery to severe physical shock.
3. Do not use an apparently damaged or deformed battery.
4. Do not use the battery in reverse polarity.
5. Do not connect directly to an electrical outlets or car cigarette lighter sockets.
6. Do not use the battery for a purpose other than those specified.
7. If the battery charging fails to complete even when a specified recharging time has elapsed, immediately stop further recharging.

#### WARNING

If a conductive foreign matter enters in the terminal of lithium ion battery, the battery may be shorted, causing fire. When storing the lithium ion battery, obey surely the rules of following contents.

- Do not place conductive debris, nail and wires such as iron wire and copper wire in the storage case.
- To prevent shorting from occurring, load the battery in the tool or insert securely the battery cover for storing until the ventilator is not seen.

### REGARDING LITHIUM-ION BATTERY TRANSPORTATION

When transporting a lithium-ion battery, please observe the following precautions.

#### WARNING

Notify the transporting company that a package contains a lithium-ion battery, inform the company of its power output and follow the instructions of the transportation company when arranging transport.

- Lithium-ion batteries that exceed a power output of 100Wh are considered to be in the freight classification of Dangerous Goods and will require special application procedures.
- For transportation abroad, you must comply with international law and the rules and regulations of the destination country.
- If the BSL36B18 is installed in the power tool, the power output will exceed 100 Wh and the unit will be classified as Dangerous Goods for freight classification.

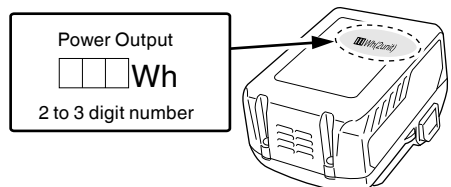

## USB DEVICE CONNECTION PRECAUTIONS (UC18YSL3)

When an unexpected problem occurs, the data in a USB device connected to this product may be corrupted or lost. Always make sure to back up any data contained in the USB device prior to use with this product.

Please be aware that our company accepts absolutely no responsibility for any data stored in a USB device that is corrupted or lost, nor for any damage that may occur to a connected device.

### WARNING

- Prior to use, check the connecting USB cable for any defect or damage.  
Using a defective or damaged USB cable can cause smoke emission or ignition.
- When the product is not being used, cover the USB port with the rubber cover.  
Buildup of dust etc. in the USB port can cause smoke emission or ignition.

### NOTE

- There may be an occasional pause during USB recharging.
- When a USB device is not being charged, remove the USB device from the charger.  
Failure to do so may not only reduce the battery life of a USB device, but may also result in unexpected accidents.
- It may not be possible to charge some USB devices, depending on the type of device.

## NAMES OF PARTS (Fig. 1 – Fig. 21)















①	Vacuum switch	⑲	Terminal
②	Name plate	⑳	Battery number
③	Dust button	㉑	Latch
④	Operation panel	㉒	Button
⑤	Remaining battery indicator switch	㉓	Hose (id 38 mm x 1.5 m long)
⑥	Remaining battery indicator lamp	㉔	Head
⑦	Battery number	㉕	Handle
⑧	Mode display lamp	㉖	Filter
⑨	Mode change-over switch	㉗	Filter cage
⑩	Suction opening	㉘	Filter seam
⑪	Caster	㉙	Suction opening (Inside of the tank)
⑫	Tank	㉚	Mouth of the tank
⑬	Clamp	㉛	Filter packing
⑭	Tool box (2XC only)	㉜	Zoom pipe
⑮	Suction opening / Exhaust opening	㉝	Master nozzle
⑯	Charge indicator lamp	㉞	Screw ring
⑰	Battery	㉟	Dust exhaust opening
⑱	Clamp lever	㊱	Power tool
⑲	Battery guard	㊲	Adapter (Optional Accessory)
⑳	Groove	㊳	Joint (Optional Accessory)

④①	Dust collection adapter (Optional Accessory)	⑤①	Release
④②	Power tool	⑤②	Fix
④③	Paper filter	⑤③	Hook bolt
④④	Suction hole	⑤④	Pipe hanger
④⑤	Cardboard	⑤⑤	Pipe holder
④⑥	Fold	⑤⑥	Crevice nozzle
④⑦	Bend	⑤⑦	Remaining battery indicator lamp
④⑧	Stopper	⑤⑧	Rubber cover
④⑨	Rubber packing	⑤⑨	USB port
⑤⑩	Lever	⑥⑩	USB cable

## SYMBOLS

### WARNING

The following show symbols used for the machine. Be sure that you understand their meaning before use.

	RP3608DA: Cordless Cleaner
	To reduce the risk of injury, user must read instruction manual.
	Always wear eye protection.
	Always wear hearing protection.
	Never stand on the cleaner.
	Warning
	Switching ON
	Switching OFF
	Disconnect the battery
	Prohibited action
	Mode selection switch
	Eco mode
	Standard mode
	Turbo mode
	Remaining battery indicator switch
	Lights ; The battery remaining power is over 75%.

	Lights ; The battery remaining power is 50% – 75%.
	Lights ; The battery remaining power is 25% – 50%.
	The battery remaining power is less than 25%. Recharge the battery soonest possible.

#### Battery

	Lights ; The battery remaining power is over 75%.
	Lights ; The battery remaining power is 50% – 75%.
	Lights ; The battery remaining power is 25% – 50%.
	Lights ; The battery remaining power is less than 25%.
	Blinks ; The battery remaining power is nearly empty. Recharge the battery soonest possible.
	Blinks ; Output suspended due to high temperature. Remove the battery from the tool and allow it to fully cool down.
	Blinks ; Output suspended due to failure or malfunction. The problem may be the battery so please contact your dealer.

#### NOTE

- To prevent the battery power consumption caused by forgetting to turn off the LED light, the light goes off automatically in about 2 minutes.
- Check the cleaner's remaining battery indicator after switching off the main unit.

## STANDARD ACCESSORIES

(1) Hose (id 38 mm x 1.5 m long) .....	1
(2) Zoom pipe .....	1
(3) Crevice nozzle.....	1
(4) Master nozzle.....	1
(5) Polyethylene bag (10 pcs.).....	1
(6) Battery (BSL36A18)* .....	2
(7) Charger (UC18YSL3)* .....	1
(8) Battery cover* .....	2
(9) Tool box*.....	1

Standard accessories are subject to change without notice.

\* (NN) specifications is excluded.

## SELECTING ACCESSORIES

The accessories of this machine are listed on page 18.  
Optional accessories are subject to change without notice.

## APPLICATIONS

- General cleaning in workplaces and others.
- Collection of fine dusts generated during grinding, cutting or drilling of concrete or wood using power tools.
- Suction of liquid such as water spill on the floor.

## SPECIFICATIONS

### 1. Power tool

Item	Model	RP3608DA
Rated voltage		36 V
Motor		DC motor
Application		Wet and Dry type
Max. Airflow		3.5 m <sup>3</sup> /min
Max. Vacuum		20.1 kPa
Details-Dry		8 L
Details-Wet		6 L
Battery available for this tool*		Multi volt battery
Dimensions (W x D x H)		331 mm x 369 mm x 382 mm
Weight		10.4 kg (BSL36A18 x 2pcs.) 10.9 kg (BSL36B18 x 2pcs.)

\* Existing batteries (BSL3660/3626X/3626/3625/3620, BSL18.... and BSL14.... series) cannot be used with this tool.

### 2. Battery

Model	BSL36A18
Voltage	36 V / 18 V (Automatic Switching*)
Battery capacity	2,450 mAh / 4,900 mAh (Automatic Switching*)
Available cordless products**	Multi volt series, 18 V product
Available charger	Sliding charger for lithium ion batteries

\* The tool itself will automatically switch over.

\*\* Please see our general catalogue for details.

## UNPACKING

- Carefully unpack the power tool.
- Take out the accessories in the tank before work.

## CHARGING

Before using the power tool, charge the battery as follows.

### 1. Connect the charger's power cord to the receptacle.

When connecting the plug of the charger to a receptacle, the charge indicator lamp will blink in red (At 1- second intervals).

### 2. Insert the battery into the charger.

Firmly insert the battery into the charger as shown in Fig. 2 (on page 2).

### 3. Charging

When inserting a battery in the charger, the charge indicator lamp will blink in blue.

When the battery becomes fully recharged, the charge indicator lamp will light up in green. (See Table 1)

#### (1) Charge indicator lamp indication

The indications of the charge indicator lamp will be as shown in Table 1, according to the condition of the charger or the rechargeable battery.

**Table 1**

Indications of the charge indicator lamp				
Charge indicator lamp (RED / BLUE / GREEN / PURPLE)	Before charging	Blinks (RED)	Lights for 0.5 seconds. Does not light for 0.5 seconds. (off for 0.5 seconds)	Plugged into power source
	While charging	Blinks (BLUE)	Lights for 0.5 seconds. Does not light for 1 second. (off for 1 second)	Battery capacity at less than 50%
		Blinks (BLUE)	Lights for 1 second. Does not light for 0.5 seconds. (off for 0.5 seconds)	Battery capacity at less than 80%
		Lights (BLUE)	Lights continuously	Battery capacity at more than 80%
	Charging complete	Lights (GREEN)	Lights continuously (Continuous buzzer sound: about 6 seconds)	
	Overheat standby	Blinks (RED)	Lights for 0.3 seconds. Does not light for 0.3 seconds. (off for 0.3 seconds)	Battery overheated. Unable to charge. (Charging will commence when battery cools)
	Charging impossible	Flickers (PURPLE)	Lights for 0.1 seconds. Does not light for 0.1 seconds. (off for 0.1 seconds) ■ ■ ■ ■ ■ ■ ■ ■ ■ ■ ■ ■ ■ ■ ■ ■ (Intermittent buzzer sound: about 2 seconds)	Malfunction in the battery or the charger

(2) Regarding the temperatures and charging time of the rechargeable battery  
The temperatures and charging time will become as shown in **Table 2**.

**Table 2**

Charger		UC18YSL3					
Battery	Type of battery	Li-ion					
	Temperatures at which the battery can be recharged	-10°C – 50°C					
	Charging voltage	V	14.4		18		
	Charging time, approx. (At 20°C)	min.	BSL14.... series		BSL18.... series		Multi volt series
			(4 cells)	(8 cells)	(5 cells)	(10 cells)	(10 cells)
		BSL1415S : 15 BSL1415 : 15 BSL1415X : 15 BSL1420 : 20 BSL1425 : 25 BSL1430C : 30	BSL1430 : 20 BSL1440 : 26 BSL1450 : 32 BSL1460 : 38	BSL1815S : 15 BSL1815 : 15 BSL1815X : 15 BSL1820 : 20 BSL1825 : 25 BSL1830C : 30	BSL1830 : 20 BSL1840 : 26 BSL1850 : 32 BSL1860 : 38	BSL36A18 : 32 BSL36B18 : 52	
USB	Charging voltage	V	5				
	Charging current	A	2				

**NOTE**

The recharging time may vary according to the ambient temperature and power source voltage.

**4. Disconnect the charger's power cord from the receptacle.**

**5. Hold the charger firmly and pull out the battery.**

**NOTE**

Be sure to pull out the battery from the charger after use, and then keep it.

**Regarding electric discharge in case of new batteries, etc.**

As the internal chemical substance of new batteries and batteries that have not been used for an extended period is not activated, the electric discharge might be low when using them the first and second time. This is a temporary phenomenon, and normal time required for recharging will be restored by recharging the batteries 2 – 3 times.

## How to make the batteries perform longer.

- (1) Recharge the batteries before they become completely exhausted.  
When you feel that the power of the tool becomes weaker, stop using the tool and recharge its battery. If you continue to use the tool and exhaust the electric current, the battery may be damaged and its life will become shorter.
- (2) Avoid recharging at high temperatures.  
A rechargeable battery will be hot immediately after use. If such a battery is recharged immediately after use, its internal chemical substance will deteriorate, and the battery life will be shortened. Leave the battery and recharge it after it has cooled for a while.

### CAUTION

- If the battery is charged while it is heated because it has been left for a long time in a location subject to direct sunlight or because the battery has just been used, the charge indicator lamp of the charger lights for 0.3 seconds, does not light for 0.3 seconds (off for 0.3 seconds). In such a case, first let the battery cool, then start charging.
- When the charge indicator lamp flickers (at 0.2-second intervals), check for and take out any foreign objects in the charger's battery connector. If there are no foreign objects, it is probable that the battery or charger is malfunctioning. Take it to your authorized Service Center.
- Since the built-in micro computer takes about 3 seconds to confirm that the battery being charged with UC18YSL3 is taken out, wait for a minimum of 3 seconds before reinserting it to continue charging. If the battery is reinserted within 3 seconds, the battery may not be properly charged.

## PRIOR TO OPERATION

### WARNING

Before use, check the following. 1 to 2 should be checked before insert the battery.

1. **Confirm that the vacuum switch is OFF. (Fig. 3)**  
If, without knowing that the vacuum switch is ON, the battery is inserted, the appliance will start suddenly, causing unexpected accidents. The vacuum switch will be turned on by pushing "ON" and it will be turned off by returning it to "OFF". Be sure to check that the vacuum switch is OFF.
2. **Order of use for batteries**  
When two batteries are installed, the battery with the least remaining power is used first until it is empty. Once empty, use is automatically switched over to the other battery.  
Use is still possible with a single installed battery.

### NOTE

When there is no more remaining power in a battery, immediately recharge the battery for convenient use later.

3. **Check the filter**

Referring to "2. Attaching the Filter" the filter should be correctly attached.

### CAUTION

Water absorption amount will severely decline if the standardly equipped cloth filter is repeatedly used to absorb liquid.

Use the separately sold nylon filter when repeatedly absorbing large amounts of water.

4. **Inserting the battery (Fig. 4)**

As you pull on the clamp lever, open the battery guard. Next, match the battery lever with the unit's groove and firmly press the battery in until you hear a click.

### CAUTION

Do not touch the terminals. Doing so may result in cutting your hand on the terminals or other unexpected injury.

5. **Removing the battery (Fig. 4)**

When removing the battery from the unit, press the latches on both sides and slide the battery upwards to pull it out.

6. **Switch operation (Fig. 5)**

During operation, the suction power will change each time the mode selection switch is pressed.

## HOW TO USE

### CAUTION

Do not use the head top as a footstool or do not sit on it. Otherwise the appliance begins to move suddenly, causing an injury.

### NOTE

Handle the hose with care. Do not bend the hose by force, or do not trample it, or do not pull it to move the cleaner. Moreover, do not put away the hose as it is bent. Otherwise troubles such as its deformation may be caused.

1. **Connecting the hose (Fig. 6)**

Press the attached hose into the suction opening of the tank until it clicks and connect it. When removing the hose, pull out the hose while pushing the button of the suction opening.

2. **Attaching the filter (Fig. 7)**

### WARNING

- Be sure to attach the filter. (cloth filter or filter for dusts) Otherwise the motor will be damaged.
- When you collect fine dusts, such as siding powder and stone powder, use the optional paper filter.
- Since it is a filter for dry and wet suction, do not remove it when you suck up liquids, such as water.

### NOTE

If the filter is wet, leave it to dry out of direct sunlight. Using the filter when wet will conspicuously reduce the suction power.

- (1) Check that the filter packing is put on the mouth of the tank.
- (2) Check that the filter cage is on the bottom of the filter.
3. **Attach the zoom pipe, master nozzles, etc.**  
When it is used as a cleaner (Fig. 8)  
Connect in order of Hose (id 38 mm × 1.5 m long), zoom pipe and Master nozzle. Connection is done by pressing in the direction of the arrow. The suction mouth for crevices can also be attached depending on the application.
4. **Connect power tools (Fig. 9)**  
Connect in order of Hose (id 38 mm × 1.5 m long) and Adapter or Joint (D) (Optional Accessory). Connection is done by pressing in the direction of the arrow.

### NOTE

- (1) When you switch ON the unit after switching it OFF, the mode change-over switch will revert to its state prior to being switched OFF.  
The unit will revert to mode [2] when set at [3].
- (2) Depending on the operating environment, the main unit's temperature protective function may activate and switch off the unit.  
Should the unit switch off, refer to TROUBLESHOOTING (Page 16).

5. **Filter cleaning (Fig. 10)**

### CAUTION

If the tank is filled with dusts, the suction power declines. Dump dusts as early as possible when they reach the half of the tank height.  
When the suction power declines during use, remove dusts in the following procedure:

## NOTE

Since the filter cleaning device operates when the suction power declines to some extent, it also operates in the following cases:

- When the suction mouth at the tip of the hose is closed.
  - When the hose is clogged with foreign matter.
- To clean the filter using a strong air flow:
- (1) Pull out the zoom pipe on the tip of the hose.
  - (2) Block off the tip of the hose with your hand and turn the power switch ON. Next, press the dust button on the top of the head for approximately one second and release the button. Repeat three times and the suction power should recover.
- If the suction power is not recovered, the tank is almost filled with dusts. Dump dusts in the tank.

## 6. Dump dusts (Fig. 11)

### WARNING

Be sure to turn off the vacuum switch and disconnect the battery.

### CAUTION

- Do not impact the tank, the filter, or the head. Otherwise they will be deformed or damaged.
- Although it is based on the amount of suction of dusts and liquids, dump dusts and liquids in the tank at least once a day and keep the appliance, the filter, etc. clean. Otherwise suction power fall, motor failure, bad smell or rusting may be caused.
- Do not hold the clamps when you dump dusts in the tank. Otherwise the clamps may be damaged.

## NOTE

Do not tilt the tank with accessories (Zoom pipe, Master nozzle, etc.) inserted in the base or in the tank. Otherwise any part may be damaged.

### WARNING

If the appliance is pushed on its side while the tank contains liquid, the liquid will get inside the motor or switch region, causing an electric shock or motor failure.

- (1) Remove the clamps (2 pieces) and raise the handle of the head.
- (2) Lightly striking the inner side of the filter several times, remove dusts attached to the filter.
- (3) Tilt the tank and dump dusts.
- (4) Attach the filter, the filter cage, the head, and the clamp in the initial positions.

## 7. Transportation and storage

### (1) How to use the handle (Fig. 12)

When carrying or moving the appliance, hold the handle of the head part. When you do not use the handle, put it in the head part.

### (2) Fixation and release of the caster (Fig. 13)

By lowering the lever of the caster with the brake, the rotation of the wheel is fixed. When releasing the fixed wheel, raise the lever. When moving with the appliance on a vehicle, fix the caster to retain the appliance. However, when you move the appliance, check that the caster is released, or the caster will be damaged.

### (3) Tool box assembly (Fig.14)

### (4) Storing the appliance during breaks (Fig. 15)

Anytime you stop work or take a break from cleaning, you can quickly store the unit by hooking the zoom pipe to the pipe holder (the hole at the top of the unit) so that it stands.

### (5) When the appliance is stored (Fig. 16)

After removing the suction opening and hose, hook the zoom pipe to the pipe holder so that it stands. Store the master nozzle, crevice nozzle and battery in the tool box.

## NOTE

When the attachments are stored in the appliance, do not apply any excess force to the attachments.

## 8. How to attach the paper filter (Optional) (Fig. 17)

### WARNING

- Be sure to turn off the appliance and remove the battery.
  - When using a paper filter, use it in combination with the standard cloth filter.
- If the paper filter gets torn, dust may get inside the motor, causing abnormal noise or fire due to overheating.

### CAUTION

When using a paper filter, avoid sucking in liquids such as water or wet dust, as this may lead to tearing of the filter.

- (1) Open the paper filter horizontally so that the suction hole in the paper filter is over the top of the tank.
- (2) Before attaching the filter to the appliance, bend the two folds in the cardboard approx. 90° in the direction of the arrow.
- (3) Match the suction hole in the paper filter with the suction opening of the appliance. Insert the filter in the direction of the arrow as shown in the illustration, so that the cardboard of the paper filter goes past the stopper on the suction opening.

## FLOAT MECHANISM

This appliance is equipped with a float mechanism to prevent water from entering in the motor when it sucks in more than a specific quantity of water. When the float operates not to suck in water, turn off the switch promptly and throw away water in the tank.

### WARNING

- With the float working, do not continue operation. Otherwise the temperature of the motor may rise abnormally causing troubles such as deformation of parts or motor burnout.
- Avoid sucking in foaming liquid such as detergent or foams. Before the float works, foams may spurt from the air outlet. If you continue to use the appliance as it is, it will lead to electric shock or failure.

## ABOUT REMAINING BATTERY INDICATOR

Remaining battery power can be verified with either the battery or with the cleaner itself. (Fig. 18)

### NOTE

- The reading for the remaining battery power may differ on the battery from that of the cleaner.
- Use the remaining battery power as a guideline since the readings may somewhat differ due to surrounding temperature or battery feature.

## HOW TO RECHARGE USB DEVICE (UC18YSL3)

- (1) Select a charging method
  - Charging a USB device from a electrical outlet (Fig. 19-a)
  - Charging a USB device and battery from a electrical outlet (Fig. 19-b)
- (2) How to recharge USB device (Fig. 20)
- (3) When charging of USB device is completed (Fig. 21)

## MAINTENANCE AND INSPECTION

### WARNING

- For inspection and maintenance, be sure to turn off the vacuum switch and disconnect the battery.
- Do not work with wet hands. May cause electric shock or injuries.

### 1. Maintenance of filter

#### NOTE

- Since a filter is a consumable, we recommend you to prepare spares.
- The cloth filter should simply be tapped even if it is considerably clogged. Strong brushing will shorten its life.
- Do not hurl a filter. May break its resin part. A clogged filter will decrease the suction power remarkably. Tap the inner side of the filter to drop off dusts regularly.

### 2. Inspecting the mounting screws

Regularly inspect all mounting screws and ensure that they are properly tightened. Should any of the screws be loose, retighten them immediately. Failure to do so could result in serious hazard.

### 3. Maintenance of the motor

The motor unit winding is the very "heart" of the power tool.

Exercise due care to ensure the winding does not become damaged and/or wet with oil or water.

### 4. Inspection of terminals (tool and battery)

Check to make sure that swarf and dust have not collected on the terminals.

On occasion check prior, during and after operation.

### CAUTION

Remove any swarf or dust which may have collected on the terminals.

Failure to do so may result in malfunction.

### 5. Check for Dust

Dust may be removed with a soft cloth or a cloth dampened with soapy water. Do not use bleach, chlorine, gasoline or thinner, for they may damage the plastics.

### 6. Storage

Storing in a place below 40°C and out of the reach of children.

### NOTE

Storing lithium-ion batteries.

Make sure the lithium-ion batteries have been fully charged before storing them.

Prolonged storage (3 months or more) of batteries with a low charge may result in performance deterioration, significantly reducing battery usage time or rendering the batteries incapable of holding a charge.

However, significantly reduced battery usage time may be recovered by repeatedly charging and using the batteries two to five times.

If the battery usage time is extremely short despite repeated charging and use, consider the batteries dead and purchase new batteries.

### CAUTION

In the operation and maintenance of power tools, the safety regulations and standards prescribed in each country must be observed.

### Important notice on the batteries for the HIKOKI cordless power tools

Please always use one of our designated genuine batteries. We cannot guarantee the safety and performance of our cordless power tool when used with batteries other than these designated by us, or when the battery is disassembled and modified (such as disassembly and replacement of cells or other internal parts).

### Information concerning airborne noise and vibration

The measured values were determined according to EN60335-2-69 and declared in accordance with ISO 4871.

Measured A-weighted sound power level: 88 dB (A)  
Measured A-weighted sound pressure level: 75 dB (A)  
Uncertainty K: 2 dB (A).

Wear hearing protection.

Vibration total values according to EN60335-2-69:

$a_h \leq 2.5 \text{ m/s}^2$   
Uncertainty K = 1.5 m/s<sup>2</sup>

### NOTE

Due to HIKOKI's continuing program of research and development, the specifications herein are subject to change without prior notice.

## TROUBLESHOOTING

Use the inspections in the table below if the tool does not operate normally. If this does not remedy the problem, consult your dealer or the HiKOKI Authorized Service Center.

### 1. Power tool

Symptom	Possible cause	Remedy
Tool doesn't run	No remaining battery power	Charge the battery.
	Battery isn't fully installed.	Push in the battery until a click is heard.
	Concrete dust is accumulated on the terminals of the battery installation compartment as well as on the battery sliding grooves.	Clean off the accumulated concrete dust with a dry cloth.
Suction power is weak. Fails to suck in dust.	The tank is full of dust or water.	Dispose of the dust or water. After that, remove any dust attached to the filter.
	Filter is clogged.	Conduct air blow dusting or remove the dust attached to the filter.
	The filter is not installed. (Not set in place)	Check to see if the filter is properly set.
	Plastic bag is incorrectly installed.	Properly install the plastic bag.
Dust leaks from the vent.	Filter is not installed. Filter is improperly installed.	Properly install the filter.
	Filter is damaged.	Replace the damaged filter.
Tool suddenly stopped	Tool was overburdened	Get rid of the problem causing the overburden.
	The battery and/or the unit is overheated.	Let the battery and/or the unit cool down.
Attachments such as the connection adapter or joint -can't be attached -fall off	The shape or the dimensions of an attachment part does not match.	Check the model in use and make sure to use the designated accessories and attachments listed in this document or in our catalogue.
Battery cannot be installed	Attempting to install a battery other than that specified for the tool.	Please install a multi volt type battery.



## 2. Charger

Symptom	Possible cause	Remedy
The charge indicator lamp rapidly flickers purple, and battery charging doesn't begin.	The battery is not inserted all the way.	Insert the battery firmly.
	There is foreign matter in the battery terminal or where the battery is attached.	Remove the foreign matter.
The charge indicator lamp blinks red, and battery charging doesn't begin.	The battery is not inserted all the way.	Insert the battery firmly.
	The battery is overheated.	If left alone, the battery will automatically begin charging if its temperature decreases, but this may reduce battery life. It is recommended that the battery be cooled in a well-ventilated location away from direct sunlight before charging it.
Battery usage time is short even though the battery is fully charged.	The battery's life is depleted.	Replace the battery with a new one.
The battery takes a long time to charge.	The temperature of the battery, the charger, or the surrounding environment is extremely low.	Charge the battery indoors or in another warmer environment.
	The charger's vents are blocked, causing its internal components to overheat.	Avoid blocking the vents.
	The cooling fan is not running.	Contact a HIKOKI Authorized Service Center for repairs.
The USB power lamp has switched off and the USB device has stopped charging.	The battery's capacity has become low.	Replace the battery with one that has capacity remaining.
		Plug the charger's power plug into an electric socket.
USB power lamp does not switch off even though the USB device has finished charging.	The USB power lamp lights up green to indicate that USB charging is possible.	This is not a malfunction.
It is unclear what the charging status of a USB device is, or whether its charging is complete.	The USB power lamp does not switch off even when charging is complete.	Examine the USB device that is charging to confirm its charging status.
Charging of a USB device pauses midway.	The charger was plugged into an electrical socket while the USB device was being charged using the battery as the power source.	This is not a malfunction. The charger pauses USB charging for about 5 seconds when it is differentiating between power sources.
	A battery was inserted into the charger while the USB device was being charged using a power socket as the power source.	
Charging of the USB device pauses midway when the battery and the USB device are being charged at the same time.	The battery has become fully charged.	This is not a malfunction. The charger pauses USB charging for about 5 seconds while it checks whether the battery has successfully completed charging.
Charging of the USB device doesn't start when the battery and the USB device are being charged at the same time.	The remaining battery capacity is extremely low.	This is not a malfunction. When the battery capacity reaches a certain level, USB charging automatically begins.



320994

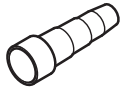

337527

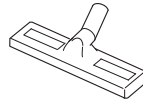

326127



321984

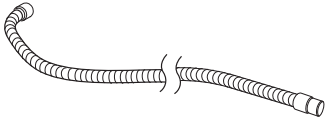

337511

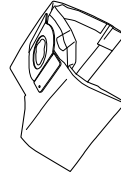

00323703

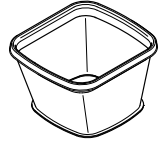

338324



# Koki Holdings Co., Ltd.

Shinagawa Intercity Tower A, 15-1, Konan 2-chome,  
Minato-ku, Tokyo, Japan

901  
Code No. C99731512 F  
Printed in China